



CONNECTION TECHNOLOGY CENTER, INC.

Smart Condition

www.smartcondition.mx
ventas@smartcondition.mx
☎ (614) 196 6239
☎ (493) 106 9062



SHORT FORM CATALOG | Q3 2025

TABLE OF CONTENTS

About CTC	3
Introducing Connect Line Wireless Solutions.....	4
Coming Soon to the PRO Line Family	5
Multipurpose Accelerometers	6
Specialty Accelerometers	7
Fully-Molded Accelerometers.....	8
Hazardous-Rated Accelerometers.....	9
Multi-Axial Accelerometers	10
Cables	11
Connectors	12
Data Collector Cordsets.....	13
Emerson / CSI Equivalent and Compatible Hardware	14
Popular Cable Adapters.....	15
Junction Boxes	16
Mounting Hardware	18
4-20 mA Process Control	21
PRO Line Proximity Probe Systems	23
TMP Line Test and Measurement Products	24



Scan here to view the digital version of our Short Form Catalog



www.smartcondition.mx
ventas@smartcondition.mx
☎ (614) 196 6239



Who We Are

At CTC, we are a family-owned and operated business passionate about providing the highest quality products backed by excellent customer service. We are the industry leader in quick delivery for stock and built-to-order products, and all CTC products are proudly made or assembled in the U.S.A.

What We Do

CTC is the world leader in the design and manufacture of vibration analysis hardware. We serve the industrial condition monitoring market with a comprehensive portfolio of industrial accelerometers, piezo velocity transducers, 4-20 mA vibration sensors, and proximity probes as well as all related mounting hardware, cabling, and junction boxes.

Our products enable efficient vibration monitoring for predictive maintenance in a wide variety of industries. Industries served include cement, mining, petrochemical, food and beverage, auto, steel, wind, paper, power generation, water and wastewater treatment, pharmaceutical, hospitals, bottling, and more.

We also serve the research and development market with our top-of-the-line series of test and measurement accelerometers and related accessories designed for use in laboratory environments. Our mission is to offer the most extensive collection of accelerometers and vibration analysis hardware products, as well as the tools for installation. Our products are compatible with multiple third-party data collectors and online monitoring systems.

Product Offerings

At CTC, we offer comprehensive product lines to meet your vibration monitoring needs. Our products reflect the input from customers and distributors around the world and are designed and tested to meet the real-world demands of plant environments. We believe our products are the highest quality on the market, which is why we back each product line with industry-leading warranties.

Benefits of Monitoring with CTC Hardware



**Improve
safety**



**Measure
inaccessible
areas**



**Limit
unwanted
downtime**



**Affordable
prices**



**Industry
leading
warranties**

INTRODUCING CONNECT LINE WIRELESS SOLUTIONS

CTC Connect is a line of wireless condition monitoring solutions for dynamic vibration signal or overall vibration signal with digital data transmission. The CTC Connect ecosystem offers you the highest quality wireless hardware on the market, with industry-leading **Bluetooth®** line-of-sight range, and is designed for integration with 3rd-party vibration analysis software.

ConnectSens™ Wireless Sensors

ConnectSens wireless sensors feature user-replaceable 3.6 V Lithium Thionyl Chloride primary battery and offer up to 4 years of unattended operation.



WS100

Triaxial overall vibration signal with temperature output, 2,100 ft. (640 m) line-of-sight range



WS200

Single axis dynamic vibration signal capture with temperature output, 1,200 ft. (366 m) line-of-sight range



WS300

Triaxial dynamic vibration signal capture with temperature output, 1,200 ft. (366 m) line-of-sight range

ConnectBridge™ Wireless Gateway



The ACCESS360 ConnectBridge Wireless Gateway and Network Controller serves as the connection between Connect-compatible hardware and the ConnectView Web App. It can both send and receive data between your Connect-compatible hardware and a TCP/IP network, and can service an unlimited number of any combination of CTC ConnectSens WS100, WS200, and WS300 sensors within range, with up to 20 concurrent connections. Includes an SD card for data storage.

ConnectView™ Web App



The complimentary ConnectView Web App is a user-friendly platform that comes preloaded on the ConnectBridge Gateway. The web app offers basic vibration tools and device management functionality like sensor configuration (WS200 and WS300 only), battery level information, and more. Designed for use with 3rd-party vibration analysis software for advanced data analysis that meets your specific needs.

The Bluetooth® word mark and logos are registered trademarks owned by Bluetooth SIG, Inc. and any use of such marks by Connection Technology Center, Inc. (CTC) is under license. Other trademarks and trade names are those of their respective owners.



Low-Cost Reverse Mount Proximity Probe Housing

DM72000 Series

- » Easily adjust the gap between the machine shaft and probe, or replace an existing cable without shutting down the machine
- » Available in top or side exit configurations
- » Durable polycarbonate body with 316L stainless steel sleeve that protects proximity probes from harsh conditions
- » Crush washer included to seal the sleeve interior between the reverse mount probe and the penetration sleeve
- » Convenient wrench flats for easy installation



MULTIPURPOSE ACCELEROMETER STYLES

CTC offers a complete line of industrial accelerometers. Our ruggedized industrial accelerometers are available in single axis, biaxial, and triaxial designs. Many configurations allow for either top or side exit options. Side exit configurations are suitable for installations in areas where height is an issue. CTC's industrial accelerometers support a diverse set of applications with sensitivity values ranging from 10 mV/g to 1000 mV/g. Dual output configurations allow for vibration and temperature outputs.

Top Exit Multipurpose Accelerometer Size Options



Side Exit Multipurpose Accelerometer Size Options

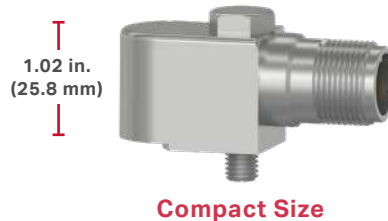
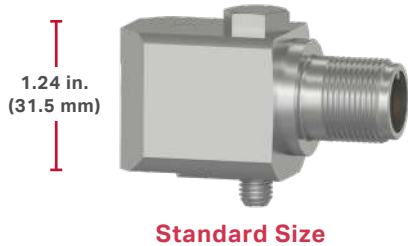

Multipurpose Accelerometer Integral Cable Options



SPECIALTY ACCELEROMETERS

Ultrasound Sensors

Dynamic IEPE vibration and ultrasound accelerometers with high amplitude resonance peak for stress wave measurements.



UEB332

100 mV/g, $\pm 10\%$,
resonant frequency:
42 kHz ± 2 kHz



UEA332

100 mV/g, $\pm 10\%$,
resonant frequency:
42 kHz ± 2 kHz



UEB334

Low cost,
100 mV/g, $\pm 15\%$,
resonant frequency:
42 kHz ± 2 kHz



UEA334

Low cost,
100 mV/g, $\pm 15\%$,
resonant frequency:
42 kHz ± 2 kHz

High Temperature Resistant Accelerometers



AC207 and AC208

100 mV/g, $\pm 10\%$,
max temp: 325 °F (162 °C)



TXEA331-HT

Premium, 100 mV/g, $\pm 5\%$,
triaxial sensor,
max temp: 325 °F (162 °C)



TR207-M12 and TR208-M12

100 mV/g, $\pm 10\%$,
RTD sensors,
max temp: 325 °F (162 °C)

Dual Output Temperature and Acceleration Sensors



TA202

100 mV/g,
10 mV/°C, $\pm 10\%$,
temp range:
-40 to 250 °F
(-40 to 121 °C)



TA204

100 mV/g,
10 mV/°C, $\pm 10\%$,
temp range:
-40 to 250 °F
(-40 to 121 °C)



TR102-M12A

100 mV/g, $\pm 10\%$,
PT100 RTD,
temp range:
-40 to 250 °F
(-40 to 121 °C)



TR104-M12A

100 mV/g, $\pm 10\%$,
PT100 RTD,
temp range:
-40 to 250 °F
(-40 to 121 °C)



FULLY-MOLDED ACCELEROMETERS

Cost-Effective Molded Accelerometers

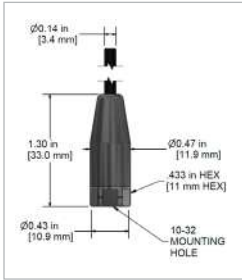

These lightweight, miniature sensors are ideal for applications with limited clearance, limited mounting surface space, or submersible applications. The minimal form factor and excellent frequency response allow this sensor to be used in a wide variety of applications.



MCB211
High Frequency,
10 mV/g,
±10%



MEB210
100 mV/g,
±10%



MEB211
High Frequency,
100 mV/g,
±10%

Low-Profile Molded Accelerometers

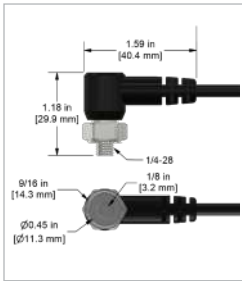

CTC's innovative solution for space-constrained applications requiring permanent mounting, our low-profile molded accelerometers feature an integrated rotating mounting base for easy sensor positioning.



MEB360
Premium,
100 mV/g,
±5%



MEB361
Low cost,
100 mV/g,
±15%



MCB360
Premium,
10 mV/g,
±5%



MCB361
Low cost,
10 mV/g,
±15%

HAZARDOUS-RATED ACCELEROMETERS

CTC offers a wide array of single-axis, biaxial, dual output, and 4-20 mA loop power vibration sensors certified for the most popular hazardous ratings, including:

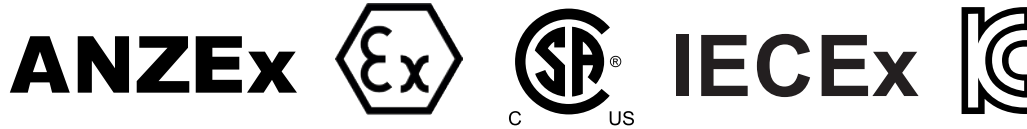

**ANZEx Zone 0,1
AC965**

Nonincendive,
intrinsically safe,
100 mV/g, $\pm 10\%$



**ATEX Zone 0,1
LP802**

Nonincendive,
intrinsically safe,
4-20 mA output
proportional to vibration
in velocity



**ATEX Zone 2
AC934**

Nonincendive,
50 mV/g, $\pm 10\%$



**CSA Class 1, Division 1
AC972**

Nonincendive,
intrinsically safe,
triaxial accelerometer,
10 mV/g, $\pm 10\%$



**CSA Class 1, Division 2
AC940**

Nonincendive,
miniature accelerometer,
100 mV/g, $\pm 10\%$



**IECEx Zone 0,1
AC979**

Nonincendive,
intrinsically safe,
biaxial accelerometer,
100 mV/g, $\pm 10\%$



**KC Zone 0,1
AC966**

Nonincendive,
intrinsically safe,
100 mV/g, $\pm 10\%$

MULTI-AXIAL ACCELEROMETERS

Dual Output Triaxial Accelerometers



TXEA331-TA
Premium,
acceleration and
temperature output,
100 mV/g, 10 mV/°C,
±5%



TXEA331-VT
Premium,
piezo velocity and
temperature output,
100 mV/in/sec, 10 mV/°C,
±5%



TXFA331-TA
Premium,
acceleration and
temperature output,
500 mV/g, 10 mV/°C,
±5%



TXFA331-VT
Premium,
piezo velocity and
temperature output,
500 mV/in/sec, 10 mV/°C,
±5%

Other Popular Triaxial Accelerometers



AC115
Low cost,
100 mV/g, ±15%



TREA330
Premium,
miniature size,
100 mV/g, ±5%



TCEB331
Premium,
miniature size,
circular shape,
100 mV/g, ±5%



TXFA331
Premium,
low frequency,
500 mV/g, ±5%

Popular Biaxial Accelerometers



AC119
Low cost,
X and Z axes,
100 mV/g, ±15%



AC979
Nonincendive,
intrinsically safe,
X and Z axes,
100 mV/g, ±10%



BSFA333-IV
Inverse voltage,
X and Z axes,
100 mV/g, ±15%

CTC offers a variety of the industry's most durable and reliable cable options for all applications and environmental criteria. Our proprietary Custom Cable Wizard application allows you to quickly and easily build cable assemblies to your exact specifications. The built-in logic takes the guesswork out of building your cable by preventing you from making incorrect and incompatible selections.

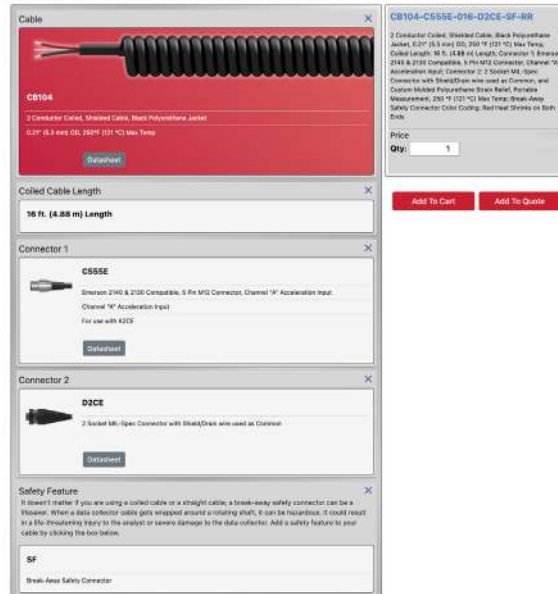

Jacket Options

- » Fluorinated Ethylene Propylene (FEP)
- » Polyurethane
- » Lightweight Polyurethane
- » PVC
- » Thermoplastic Elastomer (TPE)
- » Low Smoke Zero Halogen

Armor Options

- » Stainless steel braided sheathing
- » Stainless steel armor
- » Hydraulic hose armor

Low Cost Cable Reels

- » Our most popular cables are available in bulk 1,000 ft. reels



Conductor Options

- » 2 conductor
- » 3 conductor
- » 4 conductor
- » 6 conductor

Hazardous Zone Options

- » Class 1, Division 2 approved

CONNECTORS

CTC offers a variety of standard and specialty connectors for every possible application. CTC sensor connectors support temperatures ranging from -58 to 325 °F (-58 to 162 °C) and IP (ingress protection) ranging from IP66 to IP69.

A Series: MIL Style (C-5015) Compatible Connectors



Connector Options

- » Straight or right angle connectors
- » Hydraulic hose sleeve available
- » 2 and 3 live socket configurations available

Material Options

- » Polycarbonate
- » Polyurethane
- » Nylon
- » PPS

J Series: Mini-MIL Style Connectors



Connector Options

- » Straight connector
- » Strain relief available
- » Grounded backshell
- » 2 and 4 live socket configurations available

Material Options

- » Polycarbonate
- » Polyurethane
- » Nylon
- » PPS
- » Viton™

K Series: MIL Style (C-5015) Compatible Connectors



Connector Options

- » Straight connector
- » Strain relief
- » Grounded backshell
- » 2 and 3 live socket configurations available

Material Options

- » Polyurethane

M Series: M12 Molded Connectors



Connector Options

- » Straight connector
- » Strain relief available
- » 2, 3, 4 and 5 live socket configurations available

Material Options

- » Polycarbonate
- » Polyurethane
- » Nylon

V Series: Viton™ Protective Boot Connectors



Connector Options

- » Straight connector
- » 2, 3, and 4 live socket configurations available

Material Options

- » Viton seal with nylon insert
- » Viton seal with PPS insert



DATA COLLECTOR CORDSETS

CTC offers a variety of OEM replacement data collector cables and portable cable options for all major vibration analyzer manufacturers. Data collector cables are available in both coiled and straight cable options. Replacement cable assemblies and adapters are available for every major data collector, including:

ACOEM, ADASH Ltd., AES Reliability, Azima / Symphony Industrial AI, BETAVIB, Bently Nevada / Baker Hughes / Commtest, CEMB, Emerson / CSI, Entek / Rockwell, Pruftechnik, Schenk, SDT, SEMAPI, SKF, SPM, and Windrock

Popular Data Collector Connectors



**Emerson / CSI
C55**

Channel A acceleration input to Emerson 2130 and 2140 data collectors



**ACOEM
C494**

Single channel acceleration input for Faclon data collectors



**Bently Nevada / Baker Hughes / Commtest
C416**

Triaxial acceleration input (X, Y and Z) for VB Series data collectors



**Entek / Rockwell
C22**

Single channel acceleration input for dataPAC data collectors



**Pruftechnik
C618**

Single channel IEPE acceleration input for VIBxpert II data collectors



**SKF / Azima / Symphony Industrial AI
C66**

Single channel acceleration input for CMXA and DLI / DCA Series data collectors



**Emerson / CSI
C585**

Single channel voltage input for Emerson 2140 data collectors



**Pruftechnik
C617**

7 pin LEMO® connector for current line drive sensors, for VIBxpert II data collectors



**Bently Nevada / Baker Hughes / Commtest
C641**

Dual keyway 4 pin LEMO® connector, Triaxial acceleration input (X, Y and Z), for Scout data collectors

EMERSON / CSI EQUIVALENT AND COMPATIBLE HARDWARE

CTC is proud to offer a wide selection of the industry's highest quality vibration analysis hardware that is compatible with Emerson / CSI's broad range of data collectors.

Available Product Types



Accelerometers

Equivalent and compatible offerings



Mounting Hardware

Compatible offerings



Cable Adapters

Equivalent and compatible offerings



Data Collector Connectors

Compatible offerings



General Purpose Adapters

Compatible offerings



Cable Assemblies

Equivalent offerings



VibeNavigator™

Portable data collection extension pole for A0643TX



Scan here to view the complete Emerson / CSI Equivalent and Compatible Hardware Catalog



POPULAR CABLE ADAPTERS



CB901-1A

2 pin MIL to 2 pin MIL,
in-line feed through,
316L stainless steel



CB903-1A

2 pin MIL to 2 pin MIL,
bulkhead feed through,
0.5 in. (12.7 mm) NPT,
316L stainless steel



CB908-1A

2 pin MIL (316L stainless steel)
to BNC plug adapter
(nickel-plated brass),
with overmolded reinforcement



CB910-1A

In-line BNC jack adapter,
nickel-plated brass



CB911-1A

BNC "T" adapter,
nickel-plated zinc



CB911-3A

In-line BNC plug adapter,
nickel-plated brass



CB912-1A

2 socket MIL (black zinc alloy)
to BNC plug adapter
(nickel-plated brass),
with overmolded reinforcement



CB917-1A

BNC connector
(nickel-plated brass)
with mounting bracket
(304 stainless steel),
includes BNC cap cover
and chain



EMPP

Molded BNC jack connector
with nylon threaded protector



CB919-1A

In-line BNC plug adapter,
nickel-plated brass



CB916-2A

BNC plug to BNC plug,
nickel-plated brass,
with safety feature



CB913-1A

2 socket MIL (black zinc alloy)
to BNC jack adapter
(nickel-plated brass),
with overmolded reinforcement

JUNCTION BOXES

CTC offers the widest variety of junction boxes in the world. Our junction box solutions allow for the monitoring of remotely mounted vibration sensors which would be otherwise restricted to human access due to safety consideration. We also offer a selection of low-cost cable termination boxes that allow multiple measurement points to be routed to a single location to gather data. Many CTC junction boxes offer continuous output options for direct interface with online monitoring systems.

Premium JB Series Switch Boxes

Fully-featured NEMA 4X (IP66) rated vibration junction box with IEPE sensor condition indicator lights and convenient interface with fold-forward panel for easy wiring. Compatible with single axis, biaxial, and triaxial inputs.



JB100 / JB200
Standard Size

Fiberglass or stainless steel,
input options: 4 to 12
single, dual, or triaxial output
sensors



JB100 / JB200
Extended Capacity

Fiberglass or stainless steel,
input options: 24 to 48
single, dual, or triaxial output
sensors



JB300
Slope Top

Stainless steel slope top,
input options: 4 to 12 single, dual,
or triaxial output sensors

Legacy Switch Boxes



SB102 / SB202 / SB262
Standard Size

Fiberglass, stainless steel, or
stainless steel slope top,
input options: 4 to 12
single axis sensors



SB142 / SB242 / SB282
Standard Size

Fiberglass, stainless steel, or
stainless steel slope top,
input options: 4 to 8
dual output sensors



SSB-MODX

Single-axis switch module,
DIN rail mountable,
input options: 4 to 12
single axis sensors

JUNCTION BOXES

Cable Termination and Enclosed BNC Connection Boxes



CT101

Cable termination box, input options: 1 to 4 single output sensors



MX702

Polycarbonate mini-MAXX box, enclosed BNC connectors, 1 to 4 single output sensors



MX102 / MX202

Fiberglass or stainless steel MAXX Boxes, input options: 1 to 12 single output sensors



MX502

Aluminum Mini-MAXX Box, input options: 1 to 4 single output sensors

Cable Reduction Boxes

CTC cable reduction boxes reduce the input cabling of up to 16 individual sensors into one multi-conductor cable. Utilizing a cable reduction box can significantly reduce cabling costs for applications with long cable runs. Fiberglass and stainless steel options are available.



CR102 / CR202

Fiberglass or stainless steel, input options: 8, 12, and 16 single output sensors, -58 to 180 °F (-50 to 82 °C)



CRHT102 / CRHT202

Fiberglass or stainless steel, high temperature, input options: 12 and 16 single output sensors, -40 to 212 °F (-40 to 100 °C)

Empty Enclosures and Replacement Boards



JBA0608-FG

Empty fiberglass enclosure, 6 x 8 x 4 in. (152.4 x 203.2 x 101.6 mm)



JBA0608-SS

Empty stainless steel enclosure, 6 x 8 x 4 in. (152.4 x 203.2 x 101.6 mm)



JB900 Series

Single axis, multi-channel switch box PC boards



MOUNTING HARDWARE

CTC offers a variety of adhesive and stud mounted sensor mounting pads. Magnet mounting pad options for portable field applications are also available, including flat and two-rail mounting configurations. We also offer specialty mounting accessories for fin-cooled motors as well as a variety of mounting probe tips which allow access to traditionally hard-to-reach bearing locations.

Neodymium Iron Boron Rare Earth Magnets - Flat Surface



MH103-1B
Pull strength:
40 lbs (18 kg)



MH104-1B
Pull strength:
60 lbs (27 kg)



MH110-1A
Ultra low profile,
pull strength:
21 lbs (10 kg)

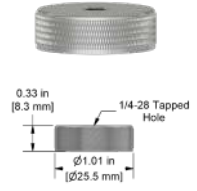

MH111-1A
Ultra low profile,
pull strength:
24 lbs (11 kg)

Neodymium Iron Boron Rare Earth Magnets - Multipurpose

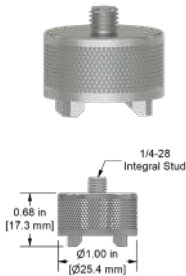

MH112-1A
Pull strength:
30 lbs (14 kg)

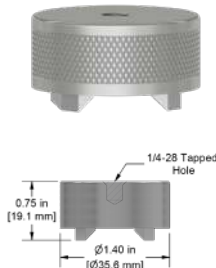

MH114-3A
Pull strength:
50 lbs (23 kg)



MH114-3T
With triaxial locating notch,
Pull strength:
50 lbs (23 kg)



MH115-2A
Pull strength:
95 lbs (43 kg)

Mounting Pads and Magnet Targets

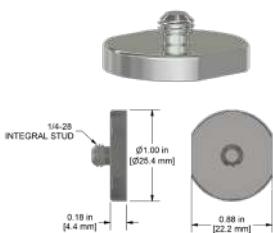

MH101-1B
Mounting pad



MH130-1A
Mounting pad



MH130-1T
Mounting pad
with triaxial locating notch



MH133-1A
Mounting target



Specialty Mounting Studs and Adapter Studs

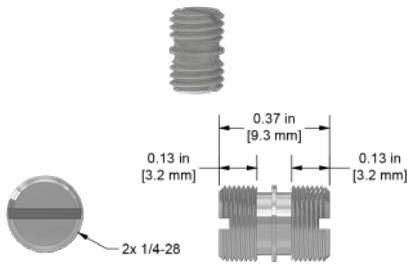

MH108-1B

1/4-28 to 1/4-28 mounting stud,
303 stainless steel

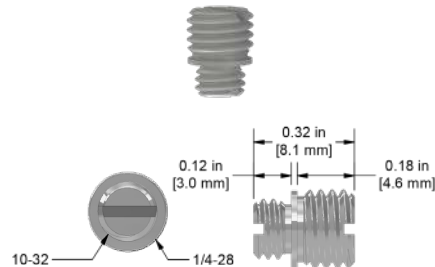

MH108-3B

1/4-28 to 10-32 adapter stud,
303 stainless steel

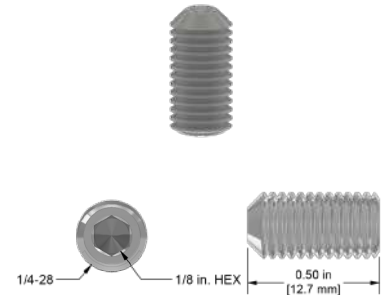

MH108-4B

1/4-28 mounting screw,
303 stainless steel

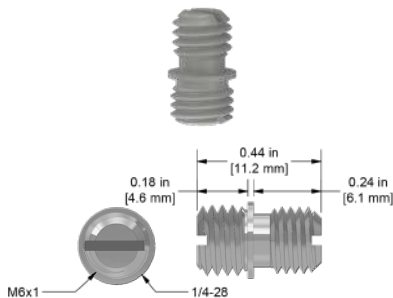

MH108-5B

1/4-28 to M6x1 adapter stud,
303 stainless steel

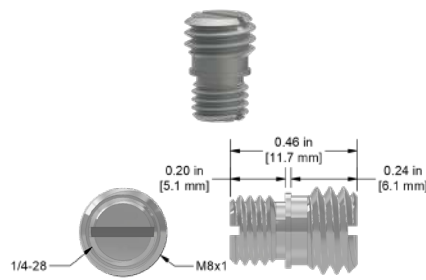

MH108-6B

1/4-28 to M8x1.25 adapter stud,
303 stainless steel

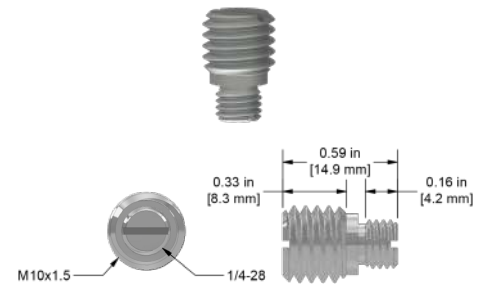

MH108-7B

1/4-28 to M10x1.5 adapter stud,
303 stainless steel

Zerk and Specialty Mounting Adapters

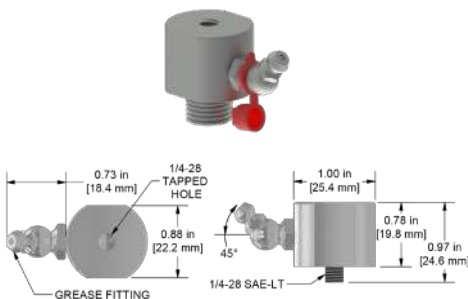

MH134-1B

45° zerk grease fitting adapter,
1/4-18 NPT mounting thread,
17-4 stainless steel

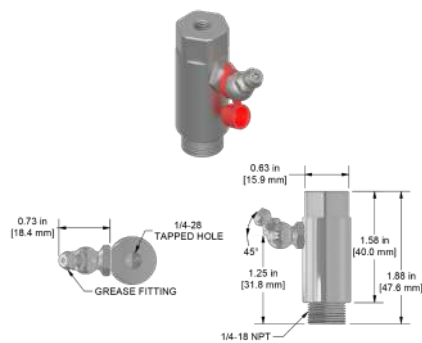

MH134-4B

Hex head 45° zerk grease fitting adapter,
1/4-18 NPT mounting thread,
17-4 stainless steel

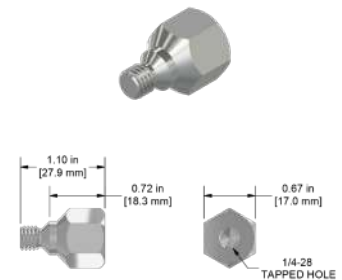

MH143-1A

Hex head mounting stud,
compatible with SPM
accelerometers,
303 stainless steel

MOUNTING HARDWARE

Accelerometer Quick Disconnects

Quick Disconnects are ideally suited for triaxial sensor use. The permanently-mounted stud creates a consistent mounting location for portable routes. The receptacle features a triaxial locating notch and ¼-turn engagement onto the stud, ensuring the sensor is oriented in the same position for every reading.



MH107-1A

Quick disconnect receptacle



MH107-3A

Quick disconnect receptacle

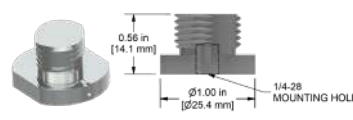

MH107-1B

Quick disconnect stud



MH107-2B

Quick disconnect stud with through-hole mounting

Motor Fin Mount Pads

Take measurements in tough-to-reach places. Our fin mount probes are perfect for narrow measurement points in fin-cooled motors. Once installed, fin mounts can be used to attract a magnet for portable route measurements or permanently mounted accelerometers.

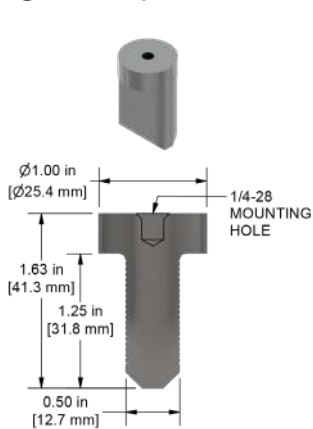

MH118-1A

17-4 stainless steel

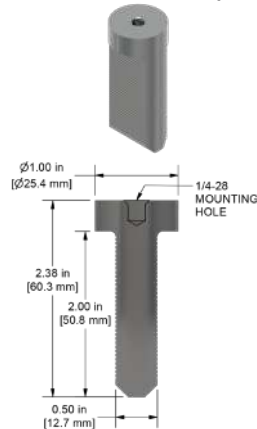

MH118-2A

17-4 stainless steel

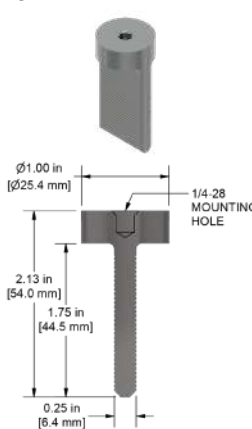

MH118-3A

17-4 stainless steel

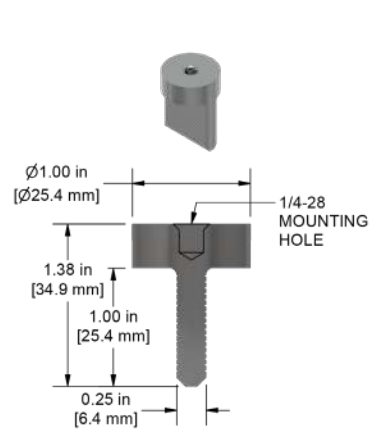

MH118-4A

17-4 stainless steel

MH117 Series Accelerometer Installation Tool Kits

Spot face and drill in one operation, with options for taps and ratcheting tap handle included.



High Speed Steel End Mill Tool Kits

Thread Sizes	End Mill Diameters
¼-28	⅝ in., 1 in., 1¼ in.
10-32	1 in.
M6x1	1 in., 1¼ in.
M8x1.25	1¼ in.

Carbide Tipped End Mill Tool Kits

Thread Sizes	End Mill Diameters
¼-28	⅝ in., 1 in., 1¼ in.

Designed For Use With Wireless Sensors

Thread Size	End Mill Diameters
¼-28	1¼ in.

MH117-10A and MH117-10B are designed for use with popular wireless sensors including:
 Acoem Eagle EGL1103000
 Acoem Sparrow SPW123000
 Baker Hughes Ranger Pro 70M303-AXX
 Erbesd Phantom EPH-V11E & EPH-V10E
 Sensoteq Tau E TS201 (Stud Version)



4-20 MA PROCESS CONTROL

CTC offers a wide array of 4-20 mA output solutions for industrial applications. CTC's standard mA loop power vibration sensors are available with velocity as well as acceleration output measurement options. CTC's loop power sensor line also includes a dual output option with both 4-20 mA output and dynamic output configurations in one sensor. Other options include 24 VDC powered transmitters that power standard IEPE accelerometers and convert the vibration to a powered 4-20 mA signal. These transmitters also offer a 4-20 mA output for temperature when coupled with CTC dual output vibration and temperature sensors. Loop power sensors are available in top or side exit connector, integral cable, and armored integral cable options.

LP200 Series Loop Power Sensors

4-20 mA output proportional to vibration in velocity



LP202



LP204



LP262

Dual output with °C temperature output



LP264

Dual output with °C temperature output

LP300 Series Loop Power Sensors

4-20 mA output proportional to vibration in acceleration



LP302



LP304



LP362

Dual output °C temperature output



LP364

Dual output with °C temperature output

Relay and Display Enclosure

For use with 1 to 4 single output loop power sensors



PMX Series

Fiberglass enclosure



Signal Conditioners

CTC's SC300 Series signal conditioners are fully customizable for your application's needs and price point. All SC300 Series signal conditioners provide process control signals to a PLC, DCS, or SCADA system that are proportional to the vibration levels set within the signal conditioner and come with a built-in temperature output.

The SC310 Series offers a single vibration band output. The SC320 Series features dual band technology which allows the user to configure two independent process control output signals from one sensor. This feature allows for the monitoring of two separate vibration / frequency bands with one device, such as both standard vibration monitoring and ultrasonic early bearing fault detection. Limited to 100 mV/g accelerometers, the SC150 provides over \$100 in savings over the SC300 Series without compromising on its excellence.



SC150

Standard signal conditioner for 100 mV/g sensors, with 4-20 mA proportional output and user selectable 0-10 or 0-5 V output



SC310

USB configurable, single band vibration/ultrasound plus temperature



SC320

USB configurable, dual band vibration/ultrasound plus temperature

4-20 mA Enclosures

CTC's signal conditioner enclosures are turnkey solutions which come fully populated with signal conditioners, power supply, and terminal blocks for easy sensor terminations. Terminal blocks come wired to the signal conditioners and the outputs from the signal conditioners are wired to terminal blocks for integration into PLC / DCS systems. The signal conditioners come configured based on customer requirements.



SCE Series

Fiberglass or stainless steel, capacity options: 1 to 8 SC Series signal conditioners



SCD100 Series

Fiberglass relay and display enclosure for 1 to 4 SC Series signal conditioners, with stack light



SCD100 Series

Fiberglass relay and display enclosure for 1 to 4 SC Series signal conditioners, without stack light

PRO LINE PROXIMITY PROBE SYSTEMS

CTC offers a complete line of proximity probe (or eddy current probe) systems designed and built to endure the harshest industrial environments. Proximity probe systems are available with probe tip sizes of FFv™ 5 mm, 8 mm, 11 mm, and 25 mm diameters. The variety of probe sizes offered allows accurate and precise machinery measurements for applications involving radial dynamic, axial rotor position, and thermal case expansion measurements. Hazardous area approved systems are also available.

Probe Tip Options



FFv™ 5 mm
Standard or armor
jacketed cable



8 mm
Standard or armor
jacketed



11 mm
Standard or armor
jacketed



25 mm
Standard or armor
jacketed

Complete Your Proximity Probe Set



Drivers
With BNC for fully-buffered
dynamic voltage output



Extension Cables
Standard or armor jacketed



NPT Pressure Seal Fitting
Standard or armor jacketed,
single or dual sided

Proximity Probe Accessories



Enclosures
Fiberglass or stainless
steel, 1 to 14 channels,
powered and 4-20 mA
options available



Reverse Mount Housing
Top or side exit,
anodized aluminum
body, 316L stainless
steel sleeve



Mounting Blocks
Aluminum or phenolic,
clamping or
non-clamping



Mounting Bushings
316L stainless steel

TMP LINE TEST AND MEASUREMENT PRODUCTS

TMP Line products, CTC's line of lightweight and low profile test and measurement instruments, are thoughtfully engineered to provide efficient and reliable research-grade data measurements at the industry's lowest price point.

Test and Measurement Accelerometers

Our TMP sensors are lightweight and low profile, making them suitable for many laboratory testing and general purpose applications. Constructed with titanium cases and having frequency ranges up to 30 kHz, TMP sensors are among the highest quality vibration sensors in the world. All sensors come packaged in a complimentary, reusable storage case to protect your investment.

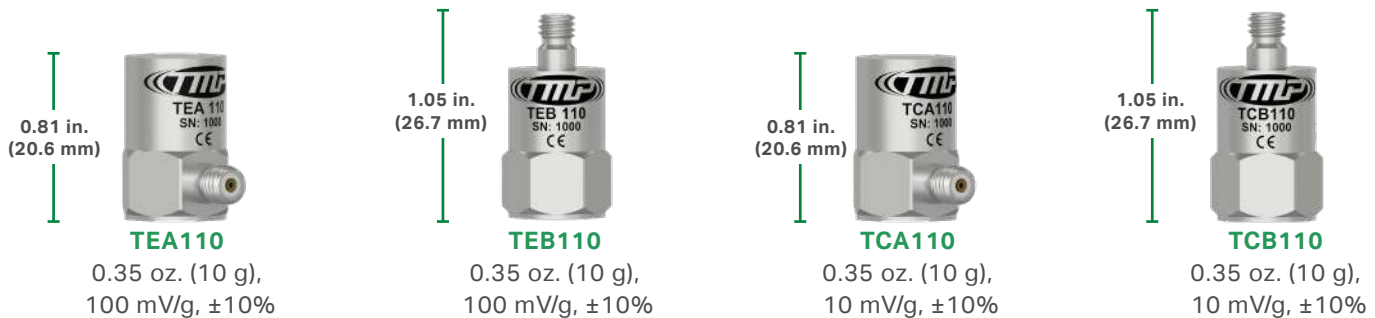

Test and Measurement Mounting Bases

Our lightweight, low profile mounting bases are designed for superior performance in research and development applications.



Test and Measurement Coaxial Cabling and Connectors

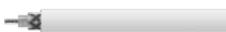

TMC01
White FEP jacket



TMC02
Black PVC jacket



TMC03
Green PTFE jacket



EC
BNC jack connector



FC
BNC plug connector



MD10
10-32 male connector

